

Article number: 03061006

Description: Fluro Rod End GI 6-SN
Special lubricating nipple

Measures

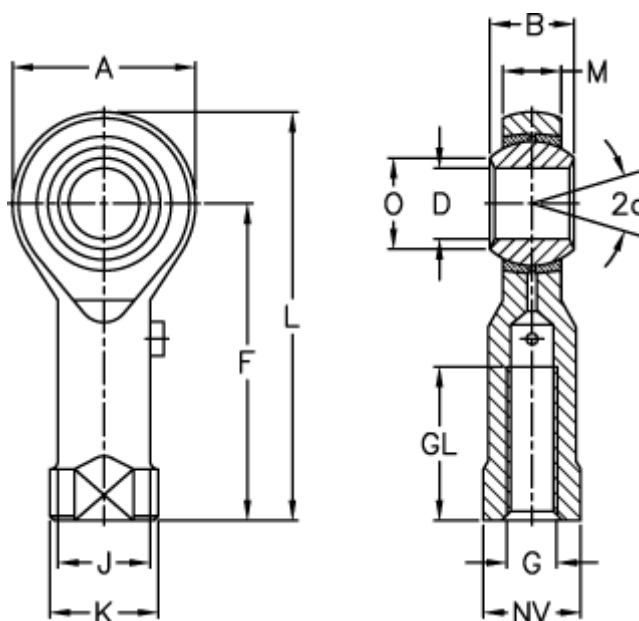

A	= 20	J	= 10	Weight (g) = 27
a (degrees)	= 13	K	= 13	
B	= 9	L	= 40	
D	= 6	M	= 6.75	
Dynamic load C (kN)	= 3.2	NV	= 11	
F	= 30	O	= 8.9	
G	= M6	Permissible rpm	= 760	
GL	= 12	Static load C0 (kN)	= 11.9	